

LG-Power™

LC-M32-FHD-165-C-A

CURVED GAMING MONITOR



USER MANUAL

TABLE OF CONTENTS

1. Safety precautions
2. Maintenance
3. Product introduction
4. Installation
5. Wall-mounting installation
6. Cable connection
7. Display operation
8. Basic troubleshooting
9. Basic parameters

1. Safety precautions

- Keep the monitor away from water sources or damp places, such as bath rooms, kitchens, basements and swimming pools.
- Make sure the monitor is placed on a flat surface. If the monitor falls down, it may cause injury or a damage to the device.
- Store and use the monitor in a cool, dry and well ventilated place, and keep it away from emission and heat sources.
- Do not cover or block the vent hole in the rear casing, and do not use the product on a bed, sofa, blanket or similar objects.
- The range of the supply voltage of the monitor is printed on the label on the rear casing. If it is impossible to determine the supply voltage, please consult the distributor or local power company.
- If the monitor will not be used for a long period, please unplug it from the electrical outlet.
- Please use a reliable earthing socket, do not overload the socket, or it may cause fire or electric shock.
- Do not put foreign matters into the monitor, or it may cause short circuits resulting fire or electric shock.
- Do not disassemble or repair this product by self to avoid electric shock. If faults occur, please contact the after-sales service directly.
- Do not pull or twist the power cable forcedly.

2. Maintenance

CAUTION: Unplug the power cable from the outlet before cleaning the monitor.

- To clean your screen, slightly moisten a soft, clean cloth with water.
 - Please use a special screen-cleaning tissue if possible.
 - Do not use benzene, thinner, ammonia, abrasive cleaners or compressed air.
 - Inappropriate cleaning solutions may damage the monitor or leave a milky film on the screen or the housing.
 - Unplug the monitor if you are not going to use it for a longer time period.
 - Do not expose the monitor to dust, liquids or a humid environment.
 - In case the monitor gets in touch with any liquid, wipe it down immediately using a dry cloth.
- In case any liquid gets spilled into the ventilation holes, do not use the monitor anymore.
Please contact a professional service technician.

Legal note:



The terms HDMI, HDMI High-Definition Multimedia Interface, HDMI Trade Dress and the HDMI Logos are trademarks or registered trademarks of HDMI Licensing Administrator, Inc.

3. Product introduction

Packing list

- Please check that the package of the monitor contains all parts. If any part is missing, please contact your retailer.
- Note: Additional screws may be used as spare parts.
Display / base parts and screws / HDMI cable / power adapter / user manual

4. Installation

Installation of the base:

1. Tilt the stem into the opening on the back of the monitor housing (1) and push it down (2).
2. Mount the base to the stem and fix it with two screws (3).

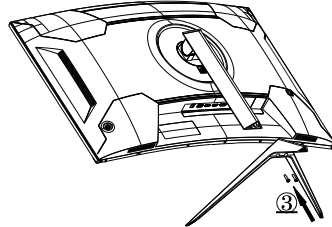
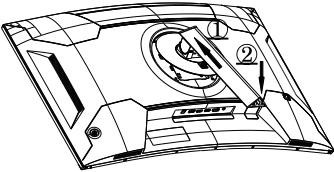

3. You have completed the installation.

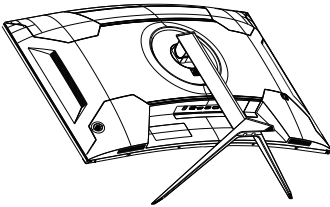

Deinstallation of the base (e.g. if you want to change to wall-mounting):

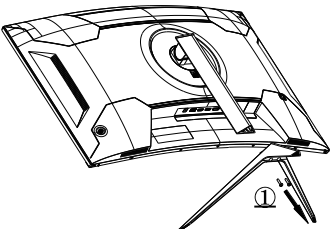

3. Remove the stem from the back side of the monitor (4).

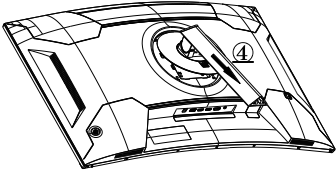

 Note: Do not press on the liquid crystal screen with hand your to avoid damage to the screen panel.

5. Wall-mounting installation

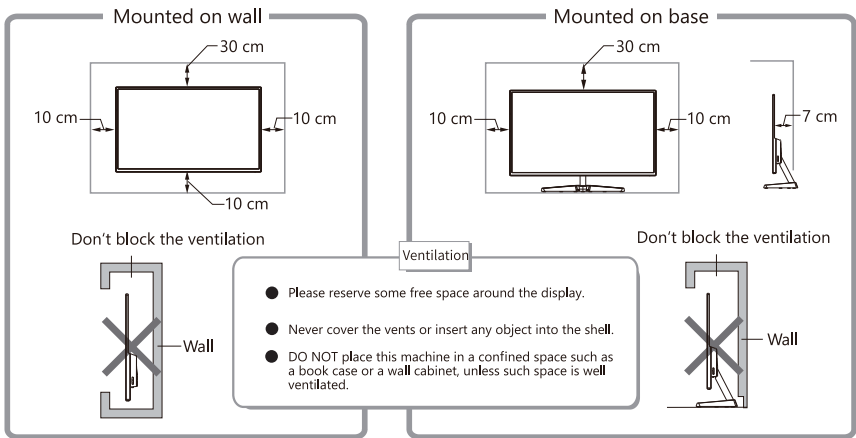

1. Take out the wall mount assembly and lock the wall mount assembly with screws.

2. Note: Hang the assembled product on a hard wall. Do not pinch the screen with your hands to avoid damaging the screen.

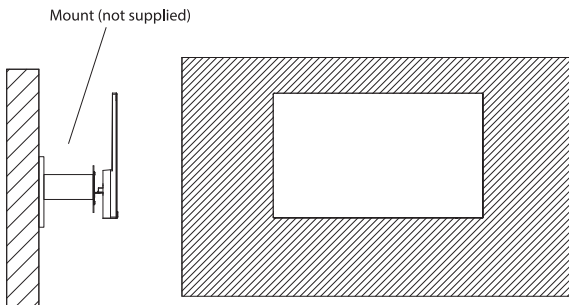

Note: In order to prevent the monitor from falling when it is used on the wall, please install it properly and securely. Do not place or hang any objects on the wall bracket.

6. Cable connection

* Note: If the power cable or signal cable is damaged, you must replace it immediately.

Use a DisplayPort (preferred) or HDMI cable to connect your monitor to the graphics card output of your computer.

Connect the power adapter to the power connector of your monitor.

You may connect headphones or speakers to your monitor.

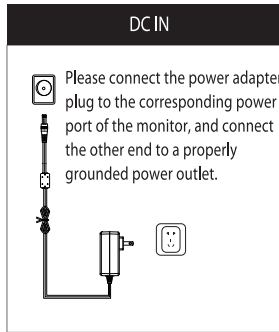
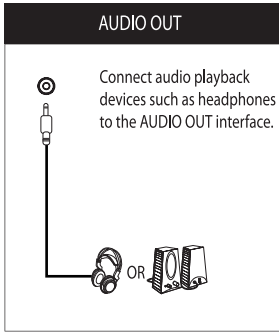
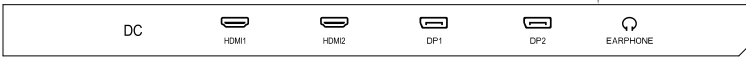
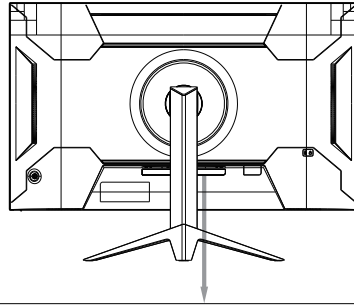

7. Display operation

7.1 Indicator light

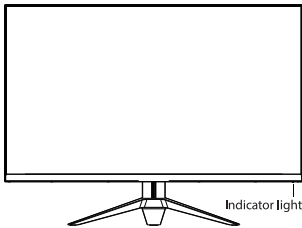

Steady blue light indicates that the power is on and the monitor works normally.

Red blinking light indicates that the monitor is in its energy saving mode until it receives a new signal from the computer.

If the monitor is fully turned off, the indicator light will also be turned off.

Please make sure your computer is turned on and operates normally, check if all video cables are fully plugged in and/or connected to the monitor.

7.2 Rocker switch / OSD menu

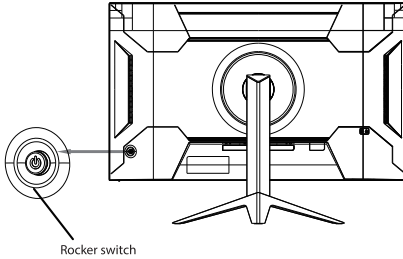

Basic function:

▲	Rocker switch up	Signal source input
▼	Rocker switch down	Volume adjustment shortcut key
◀	Rocker switch left	Game Plus shortcut key
▶	Rocker switch right	Preset shortcut key
	Press rocker switch	Short press to turn on the machine/Open menu,press and hold for 3s to turn off the machine

Entering the function menu:

▲	Rocker switch up	Same menu single direction up move
▼	Rocker switch down	Same menu single direction down move
◀	Rocker switch left	Return to the previous menu
▶	Rocker switch right	Enter/Confirm
	Press rocker switch	Short press to Close menu,/press and hold for 3s to tuen off the machine

7.3 Panel protection

When the video signals provided by the computer exceed the frequency range of the display, the horizontal and field synchronizing signals will be shut down to protect the display. Set the output frequency of the computer to a lower value within the range of the monitor.

7.4 Monitor adjustment

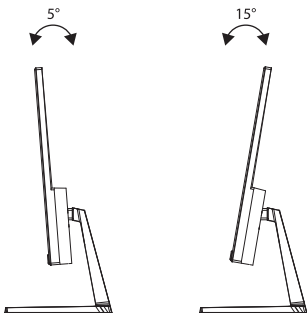

Tilting angle

-5° (±2.0°) - +15° (±2.0°)

8. Basic troubleshooting

Issue	Troubleshooting
No display / the power indicator LED is off	Check if all cables are connected correctly (power and video signal) and if the monitor has been fully shut down.
Blurry image, wrong size	Enter the menu „image settings“ and select „Auto image adjust“.
Dark image	Enter the menu „Brightness and contrast“ to adjust the according values.
Overheated monitor	Leave at least 5 cm (better 10 cm) free space for ventilation around the monitor, do not cover the housing of the monitor.
Dark or light spots after turning the monitor on	The backlight may be illuminated unevenly due to temperature differences at start-up. It may take up to 20 minutes, then the dark/light spots of the display will be corrected automatically.
Blinking, shaking or distorted image	Check your computer's display setting and correct the resolution and refresh rate.
Unknown sound after turning off the monitor	This may happen when the power-related components of the monitor discharge after turning it off.

9. Basic parameters

Product type	Liquid Crystal Display		
Product model	LC-M32-FHD-165-C-A		
Screen size	31,5" / 80,01 cm		
Aspect ratio	16:9		
Viewing angle	178° (H) / 178° (V)		
Pixel pitch	0,12125 mm (H) x 0,36375 (V) mm		
Contrast ratio	3000:1 (typ.)		
Colours	16,7 M		
Resolution	1920 x 1080 pixel		
Maximum refresh rate	165 Hz		
Power specifications	DC 19,0 V $\overline{=}$ 3,42 A The standard voltage and current may vary with countries, please refer to the label at the back of the product.		
Product dimensions	Without base	711,0 × 422,7 × 106,1 mm	
	With base	711,0 × 526,0 × 251,0 mm	
	Net Weight	approx. 6,0 kg	
	Gross Weight	approx. 8,2 kg	
Tilting angle	Forward tilting: -5°; backward tilting: 15°		
Rotation angle	NA		
Height angle	NA		
Pivot angle	NA		
Environmental conditions	Usage	Temperature: 0° C ~ +40° C	humidity: 20 % ~ 85 %
	Storage	Temperature: -10° C ~ 60° C	humidity: 10% ~ 90%
		altitude: ≤ 5000m	

LC-POWER™

Silent Power Electronics GmbH

Formerweg 8

47877 Willich

Germany

www.lc-power.com